

FLOOR TRIMS

TRANSITION STRIPS FOR FLOOR FINISHES



GRADUS

Why Gradus

Quality, performance and service are at the heart of everything we do. Founded in 1966, Gradus has over 50 years of extensive knowledge and is the market leader offering the widest choice of flooring accessories.

Gradus are committed to helping you and your customers every step of the way. Whether it's advice on product selection or simply just the assurance of delivering the right product to the right place at the right time, we can offer you complete piece of mind through our dedicated Sales and Technical Support teams should you ever need us.



NBS Source
PARTNER

Contents

Our "Floor Trims" brochure showcases selected Gradus profiles ideal for use with LVT or other types of modular flooring such as woods, ceramics and carpet tile.

It encompasses a wide range of trims, to not only provide solutions for common everyday occurrences, but also for those unusual installation scenarios that you may encounter from time to time where a specialist type of trim is needed.

To view the full Gradus range, visit our website at www.gradus.com for more information. Here you'll find further details on individual profiles and have access to download any supporting literature such as installation instructions and cleaning & maintenance guidelines.

Transition Strips

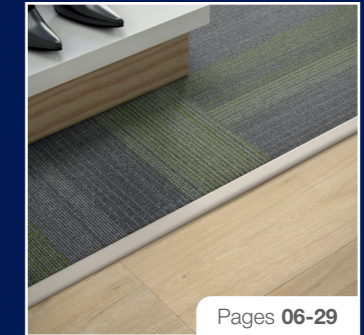

Multi-Purpose Trims



Cover Strips

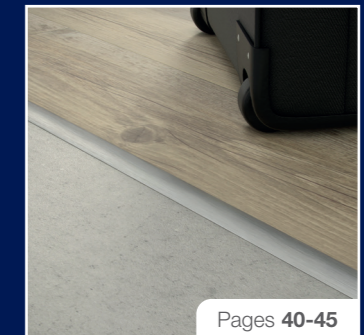

Skirting & Coving

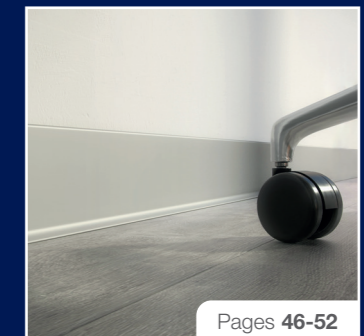

Floor Trims

Floor trims help to reduce the risk of accidents by providing a safe transition between floorcoverings. They can also provide a safe joint where wheeled traffic is expected, ensuring that trolleys can move freely between different types and heights of floorcovering.

Gradus offer floor trims in a variety of shapes and sizes to suit an array of floorcoverings ranging from LVT, woods, ceramics and other types of modular flooring.

We understand that selecting the right trim can sometimes be a complex process and it's important to always consider a combination of the safety, performance and aesthetic requirements for your intended application.

What to consider when selecting a Floor Trim?

01 Safety

- The type of environment?
 - Is the area prone to spillages or wet floors?
- If carpet or carpet tile is present, have you considered its compressed thickness?
 - What type of profile is needed – i.e. ramp top, twin top, one-piece or two-piece etc?

02 Performance

- Volume of pedestrian traffic anticipated?
 - Any likelihood of wheeled traffic?
- Cleaning and maintenance regimes expected?
 - Is a gap for natural expansion required?

03 Aesthetics

- Any particular colours, finishes or materials preferred?
- Would you like the floor trim to blend in with the surrounding environment or act as a highlight to define a walkway or breakout area for example?
 - Is a straight or curved floor trim required?

Transition Strips

| | |
|---|-------|
| Luxury Trim System..... | 08-09 |
| MTS Multi-Trim System – PVC-u & Aluminium | 10-11 |
| Clip-Top | 12-13 |
| Clip-Top fx | 14-15 |
| Design-Clip | 16 |
| PPS System | 17 |
| Mono-Clip System..... | 18 |
| Trans-Edge Trims | 19 |
| Edge Trims | 20 |
| Nap Trims | 21 |
| Square Edge Trims | 22-23 |
| Finishing Trims | 24 |
| Joint Trims | 25 |
| Threshold Trims | 26 |
| Transition T Profiles | 27 |
| Ramp Edges – Pvc & Aluminium | 28-29 |

Multi-Purpose Trims

| | |
|--|-------|
| Aluminium Multi-Purpose Trims..... | 32-36 |
| Stainless Steel Multi-Purpose Trims..... | 37 |
| Brass Multi-Purpose Trims | 38-39 |

Cover Strips

| | |
|------------------------------------|-------|
| Stainless Steel Cover Strips | 42-44 |
| Brass Cover Strips | 44 |
| Aluminium Cover Strips | 45 |

Floor Trim Colours

We offer a choice of colours and finishes to suit virtually any environment. Whether it's a premium bronze finish to blend with the surroundings at a 5-star hotel or to act as a highlight within a high-street retail store, Gradus has a colour and finish to suit your specific needs.

Below you can view all the different colours and finishes based on the products featured within this brochure.

Bronze / Brass

Polished Brass / F7



Polished Bronze



Below is a selection of specialist finishes that are applied to a polished brass material.

Polished Chrome



Satin Chrome



Brushed Stainless Steel



Pearl Nickel



Satin Nickel



Aluminium

Mill Finish / Natural



F0 Natural



F3 Polished



Below is a selection of finishes that are applied to aluminium material.

Polished Silver



Etched Silver



F4 Silver Anodised



F5 Gold Anodised



Stainless Steel

F8 Polished



F8G Matt



Pvc Standard

Black LRV: 5



Brown LRV: 6



Granite LRV: 13



Bluebell LRV: 8



Dove LRV: 27



Fawn LRV: 18



Clay LRV: 48



Note:
LRV readings apply to the following products:

MTS Multi-Trim System - PVC-u (page 10)
Clip-Top (pages 12-13)
Clip-Top fx (pages 14-15)

For details of LRV readings for all other products, contact Gradus on 01625 428922.

Pvc Metallics

Burnt Almond LRV: 10



Zinc LRV: 15



Doubloon LRV: 21



Platinum LRV: 42



Silver LRV: 49



Wood Finish

H30 - Light Oak



H61 Grey Oak

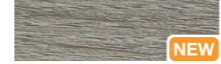

H64 Cream Oak



H65 Light Grey Oak



H81 Walnut



The above are wood effect finishes that are applied to aluminium material.

Floor Trim Colour Availability

To find out which colours and finishes are available within each range, please refer to the following colour availability table.

Non-standard colours are also available and special colours can be matched upon request subject to minimum quantity and lead time. For further information contact Technical Support on 01625 428922.

| Material | Colour/Finish | Luxury Trim System | Clip-Top PVC-u, Clip-Top fx, Multi-Trim System PVC-u | CET5, GT61R | Multi-Trim System Aluminium | Clip-Top Metallic, GT61M | AJC-F4, Design Clip, ET-EBF4, JT-EBF4, TP-F4 | PPS System | Mono-Clip System | ACS38, ACS52, ACT, ANT, CG, TA | ACS441, ACS444, ACS470S, ET367, ET, JT, RT, TH382, TH383 | BCT | TH495 | CTR, CVT, POR, T | BCS, ETR-F7, ETR-GF7, TP-F7 | ETR-F0, ETR-GF0, ETR-UFO | ETR-GF8, SCSP, SCS-SF8 | SCS, SCSM, SCS-SF8G | ACS-F3 |
|----------------------|-------------------------|--------------------|--|-------------|-----------------------------|--------------------------|--|------------|------------------|--------------------------------|--|-----|-------|------------------|-----------------------------|--------------------------|------------------------|---------------------|--------|
| Bronze / Brass | Polished Chrome | • | | | | | | | | | | | | | | | | | |
| | Satin Chrome | • | | | | | | | | | | | | | | | | | |
| | Brushed Stainless Steel | • | | | | | | | | | | | | | | | | | |
| | Pearl Nickel | • | | | | | | | | | | | | | | | | | |
| | Satin Nickel | • | | | | | | | | | | | | | | | | | |
| | Polished Brass / F7 | • | | | | | | | | | | | | | | | | | |
| Aluminium | Polished Silver | | | | • | | | | | | | | | | | | | | |
| | F3 Polished | | | | | | | | | | • | | | | | | | | |
| | Mill Finish / Natural | | | | | | | | | | | | | | | | | | • |
| | F0 Natural | | | | | | | | | | | | | | | | | | |
| | Etched Silver | | | | • | | | | | | | | | | | | | | |
| | F4 Silver Anodised | | | | | | • | | | | | | | | | | | | |
| Pvc Standard | Black | | • | • | | | | | | | | | | | • | | | | |
| | Brown | | • | • | | | | | | | | | | | • | | | | |
| | Granite | | • | • | | | | | | | | | | | • | | | | |
| | Bluebell | | • | • | | | | | | | | | | | | | | | |
| | Dove | | • | • | | | | | | | | | | | • | | | | |
| | Fawn | | • | • | | | | | | | | | | | | | | | |
| Pvc Metallics | Burnt Almond | | | | | • | | | | | | | | | | | | | |
| | Zinc | | | | | • | | | | | | | | | • | | | | |
| | Doubloon | | | | | • | | | | | | | | | • | | | | |
| | Platinum | | | | | • | | | | | | | | | • | | | | |
| | Silver | | | | | • | | | | | | | | | • | | | | |
| | Wood Finish | H30 - Light Oak | | | | | | | | | | | | | | | | | |
| H61 - Grey Oak | | | | | | | | | | | | | | | | | | | |
| H64 - Cream Oak | | | | | | | | | | | | | | | | | | | |
| H65 - Light Grey Oak | | | | | | | | | | | | | | | | | | | |
| H81 - Walnut | | | | | | | | | | | | | | | | | | | |
| Stainless Steel | F8 Polished | | | | | | | | | | | | | | | | | | |
| | F8G Matt | | | | | | | | | | | | | | | | | | • |

For Trans-Edge Trims see page 19 for details of insert types and colour availability.

Please note: Due to the limitations of the printing process, colours within this catalogue should not be relied upon for colour matching. An accurate colour match can only be achieved by requesting the relevant product sample(s) from Gradus Technical Support on 01625 428922.

Transition Strips



Whether it's for use with LVT or a different type of modular floorcovering such as woods, ceramic tile or carpet tile, our transition strips help to reduce the risk of accidents by providing a safe and neat junction.

Gradus offers a comprehensive selection of everyday profiles ranging from our popular Clip-Top, Clip-Top fx, MTS, Mono-Clip, PPS and Trans-Edge ranges, through to more specialist trims designed to suit particular situations that you may only encounter occasionally.

Our range includes profiles in ramp configurations for joining floorcoverings of differing heights, "twin tops" ideal for floorcoverings of the same or similar heights, profiles for installing directly up to skirting and a variety of one-piece or two-piece profiles depending on the amount of flexibility that may be required.

Curving

- Many of the Gradus trims in this section can easily be curved by hand, however some trims require a bending machine.
- To rent, buy or for more information about bending machines please contact Technical Support on 01625 428922.

- Key**
-  Can be curved by hand.
 -  Bending machine required.

TT35/AFT15

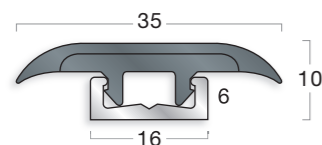

Gradus Clip-Top TT35/AFT15 profile installed at junction between loose lay LVT and carpet tile.



Luxury Trim System

Designed to create an elegant, luxurious appearance within medium traffic applications such as luxury hotels and premium residential developments, these solid brass tops are available in a choice of six premium finishes and are the perfect complement for LVT and other types of modular flooring.

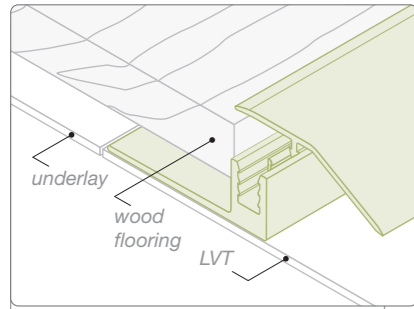

SFBR37/AFT3912 wood flooring to LVT.

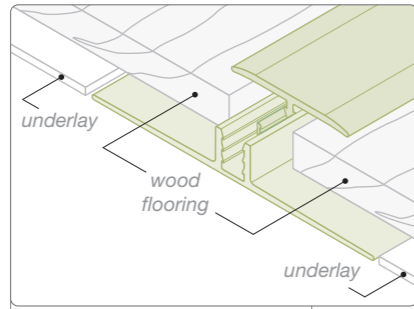

SFBT29/AFT708 wood flooring.

Installation Advice

- Compressed thickness of carpet should always be a tight fit to the internal gauge of the combined top/base
- Where appropriate a suitable gap must be left between the profile base and the flooring to allow for natural expansion
- Bases should always be fitted on top of resilient floorcoverings when used in a ramp configuration
- Bases should be fitted using cartridge adhesive and screw fixings

| CODE / PROFILE | MATERIAL | LENGTH | COLOURS / FINISHES |
|------------------|--|----------------|--|
| SFBR37 / AFT398 | Brass Top with PVC-u Connector & Aluminium Base Base available with or without carpet gripper | 2.715m 0.9m | <ul style="list-style-type: none"> Polished Chrome Satin Chrome Brushed Stainless Steel Pearl Nickel Satin Nickel Polished Brass |
| SFBR37 / AFT3912 | Brass Top with PVC-u Connector & Aluminium Base Base available with or without carpet gripper | 2.715m 0.9m | <ul style="list-style-type: none"> Polished Chrome Satin Chrome Brushed Stainless Steel Pearl Nickel Satin Nickel Polished Brass |
| SFBR37 / AFT3916 | Brass Top with PVC-u Connector & Aluminium Base Base available with or without carpet gripper | 2.715m 0.9m | <ul style="list-style-type: none"> Polished Chrome Satin Chrome Brushed Stainless Steel Pearl Nickel Satin Nickel Polished Brass |
| SFBT29 / AFT708 | Brass Top with PVC-u Connector & Aluminium Base Base available with or without carpet gripper | 2.715m 0.9m | <ul style="list-style-type: none"> Polished Chrome Satin Chrome Brushed Stainless Steel Pearl Nickel Satin Nickel Polished Brass |

Dimensions shown are nominal. Illustrations are 70% size in mm. Products subject to minor design alterations without notice.

Luxury Trim System

| CODE / PROFILE | MATERIAL | LENGTH | COLOURS / FINISHES |
|------------------|--|----------------|--|
| SFBT29 / AFT7012 | Brass Top with PVC-u Connector & Aluminium Base Base available with or without carpet gripper | 2.715m 0.9m | <ul style="list-style-type: none"> Polished Chrome Satin Chrome Brushed Stainless Steel Pearl Nickel Satin Nickel Polished Brass |
| SFBT29 / AFT7016 | Brass Top with PVC-u Connector & Aluminium Base Base available with or without carpet gripper | 2.715m 0.9m | <ul style="list-style-type: none"> Polished Chrome Satin Chrome Brushed Stainless Steel Pearl Nickel Satin Nickel Polished Brass |
| SFBT29 / AFT398 | Brass Top with PVC-u Connector & Aluminium Base Base available with or without carpet gripper | 2.715m 0.9m | <ul style="list-style-type: none"> Polished Chrome Satin Chrome Brushed Stainless Steel Pearl Nickel Satin Nickel Polished Brass |
| SFBT29 / AFT3912 | Brass Top with PVC-u Connector & Aluminium Base Base available with or without carpet gripper | 2.715m 0.9m | <ul style="list-style-type: none"> Polished Chrome Satin Chrome Brushed Stainless Steel Pearl Nickel Satin Nickel Polished Brass |
| SFBT29 / AFT3916 | Brass Top with PVC-u Connector & Aluminium Base Base available with or without carpet gripper | 2.715m 0.9m | <ul style="list-style-type: none"> Polished Chrome Satin Chrome Brushed Stainless Steel Pearl Nickel Satin Nickel Polished Brass |

Dimensions shown are nominal. Illustrations are 70% size in mm. Products subject to minor design alterations without notice.



MTS Multi-Trim System™ – PVC-u & Aluminium

A versatile and simple solution ideal for common interfaces within medium pedestrian and trolley traffic applications such as high street shops, schools, hotels and offices. Available with either PVC-u or aluminium tops, their two-piece construction enables MTS Multi-Trim System to be used with a variety of different floorcoverings including LVT, woods, ceramics and carpet tile.

Installation Advice

- Compressed thickness of carpet should always be a tight fit to the internal gauge of the combined top/base
- When installed with ceramics, wood or wood laminate flooring a suitable gap must be left between the profile base and the flooring to allow for natural expansion
- Bases should be fitted using cartridge adhesive and screw fixings

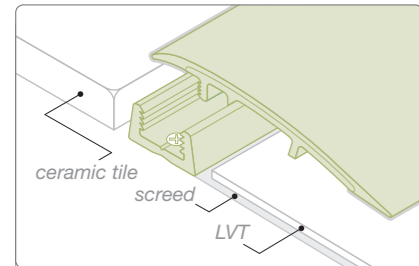

PTR1/MPTB5 ceramic tile to LVT.

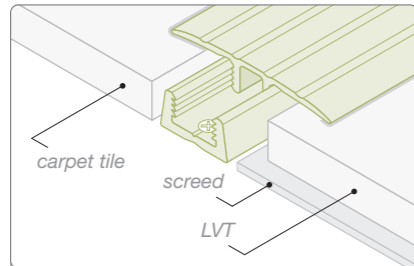

ATT42/PBT12 carpet tile to LVT.

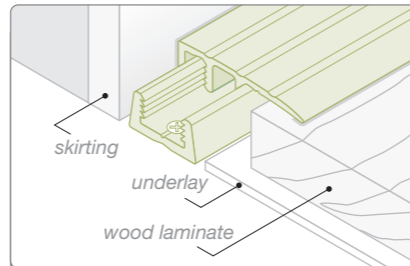

ATB33/PBT12 wood laminate to skirting.

PVC-u:

| CODE / PROFILE | MATERIAL | LENGTH | COLOURS / FINISHES |
|--------------------------|-------------------------|--------|---|
| PTT1 / MPTB5 | PVC-u Top PVC-u Base | 2.70m | <ul style="list-style-type: none"> Black Granite Brown Bluebell Fawn Dove Clay |
| PTT1 / MPTB12 | PVC-u Top PVC-u Base | 2.70m | <ul style="list-style-type: none"> Black Granite Brown Bluebell Fawn Dove Clay |
| PTT1 / MPTB16 | PVC-u Top PVC-u Base | 2.70m | <ul style="list-style-type: none"> Black Granite Brown Bluebell Fawn Dove Clay |
| PTR1 / MPTB5 | PVC-u Top PVC-u Base | 2.70m | <ul style="list-style-type: none"> Black Granite Brown Bluebell Fawn Dove Clay |
| PTR1 / MPTB12 | PVC-u Top PVC-u Base | 2.70m | <ul style="list-style-type: none"> Black Granite Brown Bluebell Fawn Dove Clay |
| PTR1 / MPTB16 | PVC-u Top PVC-u Base | 2.70m | <ul style="list-style-type: none"> Black Granite Brown Bluebell Fawn Dove Clay |

Dimensions shown are nominal. Illustrations are 70% size in mm. Products subject to minor design alterations without notice.

MTS Multi-Trim System™ – PVC-u & Aluminium

Aluminium:

| CODE / PROFILE | MATERIAL | LENGTH | COLOURS / FINISHES |
|--------------------------|-----------------------------|--------|--|
| ATT42 / PBT12 | Aluminium Top PVC-u Base | 2.70m | <ul style="list-style-type: none"> Polished Silver Etched Silver |
| ATT42 / PBT16 | Aluminium Top PVC-u Base | 2.70m | <ul style="list-style-type: none"> Polished Silver Etched Silver |
| ATB33 / PBT12 | Aluminium Top PVC-u Base | 2.70m | <ul style="list-style-type: none"> Polished Silver Etched Silver |
| ATB33 / PBT16 | Aluminium Top PVC-u Base | 2.70m | <ul style="list-style-type: none"> Polished Silver Etched Silver |
| ATR45 / PBT12 | Aluminium Top PVC-u Base | 2.70m | <ul style="list-style-type: none"> Polished Silver Etched Silver |
| ATR50 / PBT16 | Aluminium Top PVC-u Base | 2.70m | <ul style="list-style-type: none"> Polished Silver Etched Silver |

Dimensions shown are nominal. Illustrations are 70% size in mm. Products subject to minor design alterations without notice.



These two-piece profiles allow design flexibility in heavy pedestrian and medium wheeled traffic environments including department stores, high street shops, hospitals, schools, hotels and offices. The tops can be replaced so that the colour can be altered as part of a refurbishment programme, or if a worn or damaged section needs to be changed, without renewing the base or disrupting the fitted floorcovering.

Installation Advice

- Compressed thickness of carpet should always be a tight fit to the internal gauge of the combined top / base
- Clip-Top bases should always be fitted on top of the resilient floorcovering when used in a ramp configuration
- Bases should be fitted using cartridge adhesive and screw fixings

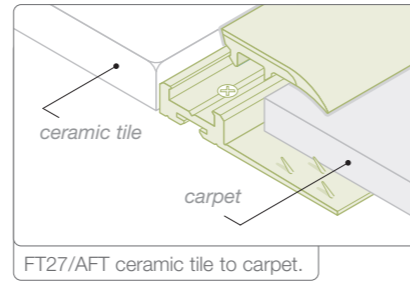
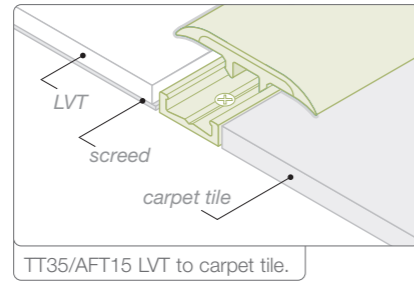
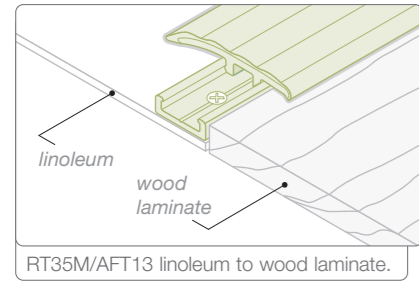

Curving Clip-Top

Curves between the minimum and maximum radii can be factory fabricated subject to approval of template or detailed drawing (showing radius details) by the Technical Department. Curves greater than the maximum radius can be curved on-site or by Gradus on request. Curves less than the minimum radius cannot be curved.

| Tops | | | Bases | | | CONVEX |
|---------|----------------|----------------|---------|----------------|----------------|---------------------------------|
| Profile | Min. Radius mm | Max. Radius mm | Profile | Min. Radius mm | Max. Radius mm | |
| FT27 | 250 | 800 | AFT12 | 250 | 6000 | Higher (carpet) / Lower (vinyl) |
| RT35M | 1000 | 3500 | AFT13 | 250 | 6000 | |
| RT42 | 1000 | 3500 | AFT14 | 250 | 6000 | CONCAVE |
| RT52 | 800 | 3500 | AFT15 | 250 | 6000 | |
| TT25M | 500 | 800 | AFT17 | 250 | 7000 | |
| TT35 | 250 | 800 | AFT28 | 600 | 9000 | |

| CODE / PROFILE | MATERIAL | LENGTH | COLOURS / FINISHES |
|---|--------------------------|--------|---|
| TT35 / AFT45 UK/EU Registered Design no 9/001201941 | PVC-u Top Aluminium Base | 2.50m | Black, Granite, Brown, Bluebell, Fawn, Dove, Clay |
| TT35 / AFT15 UK/EU Registered Design no 9/001201941 | PVC-u Top Aluminium Base | 2.50m | Black, Granite, Brown, Bluebell, Fawn, Dove, Clay |
| TT35 / DFT80 UK/EU Registered Design no 9/001201941 | PVC-u Top Aluminium Base | 2.50m | Black, Granite, Brown, Bluebell, Fawn, Dove, Clay |
| TT35 / AFT17 UK/EU Registered Design no 9/001201941 | PVC-u Top Aluminium Base | 2.50m | Black, Granite, Brown, Bluebell, Fawn, Dove, Clay |
| TT35 / AFT UK/EU Registered Design no 9/001201941 | PVC-u Top Aluminium Base | 2.50m | Black, Granite, Brown, Bluebell, Fawn, Dove, Clay |

Dimensions shown are nominal. Illustrations are 70% size in mm. Products subject to minor design alterations without notice.

| CODE / PROFILE | MATERIAL | LENGTH | COLOURS / FINISHES |
|---|-----------------------------------|--------|---|
| TT35 / DFT UK/EU Registered Design no 9/001201941 | PVC-u Top Aluminium Base | 2.50m | Black, Granite, Brown, Bluebell, Fawn, Dove, Clay |
| TT25M / AFT14 | Metallic PVC-u Top Aluminium Base | 2.50m | Burnt Almond, Zinc, Doubleloom, Platinum, Silver |
| TT25M / AFT12 | Metallic PVC-u Top Aluminium Base | 2.50m | Burnt Almond, Zinc, Doubleloom, Platinum, Silver |
| RT42 / AFT28 UK/EU Registered Design no 9/001201941 | PVC-u Top Aluminium Base | 2.50m | Black, Granite, Brown, Bluebell, Fawn, Dove, Clay |
| RT52 / AFT28 UK/EU Registered Design no 9/001201941 | PVC-u Top Aluminium Base | 2.50m | Black, Granite, Brown, Bluebell, Fawn, Dove, Clay |
| RT35M / AFT13 | Metallic PVC-u Top Aluminium Base | 2.50m | Burnt Almond, Zinc, Doubleloom, Platinum, Silver |
| FT27 / AFT15 | PVC-u Top Aluminium Base | 2.50m | Black, Granite, Brown, Bluebell, Fawn, Dove, Clay |
| FT27 / AFT45 | PVC-u Top Aluminium Base | 2.50m | Black, Granite, Brown, Bluebell, Fawn, Dove, Clay |
| FT27 / AFT17 | PVC-u Top Aluminium Base | 2.50m | Black, Granite, Brown, Bluebell, Fawn, Dove, Clay |
| FT27 / AFT | PVC-u Top Aluminium Base | 2.50m | Black, Granite, Brown, Bluebell, Fawn, Dove, Clay |

Dimensions shown are nominal. Illustrations are 70% size in mm. Products subject to minor design alterations without notice.



Clip-Top fx®

Featuring a two-piece design, our Clip-Top fx profiles are suitable for medium pedestrian and wheeled traffic applications including high street shops, schools, hotels and offices. They are particularly suited for applications where a regular refurbishment programme is expected or added flexibility to change tops is preferred. A choice of bases are available with aluminium for straights or PVC-u for curves to allow easy forming on-site without the need for any heat application.

Installation Advice

- Compressed thickness of carpet should always be a tight fit to the internal gauge of the combined top / base
- Clip-Top fx bases should always be fitted on top of the resilient floorcovering when used in a ramp configuration
- Bases should be fitted using cartridge adhesive and screw fixings

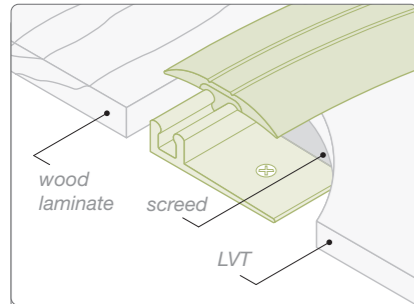

FXT31/FXB336 wood laminate to LVT.

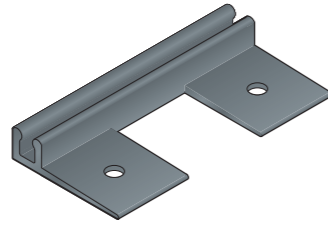

PVC-u bases are pre-punched with tabs and fixing holes for on-site curving. Latex screed should be used with LVT floorcoverings to prevent the pre-punched base shadowing through.

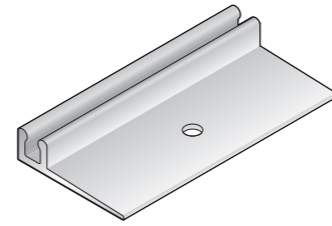

Aluminium bases have a solid flange for straight lengths.

| CODE / PROFILE | MATERIAL | LENGTH | COLOURS / FINISHES |
|----------------------------|--|--------|--|
| FXT21 / FXB336 | 400mm min curve on-site Replaceable Tops PVC-u Top PVC-u Base | 2.50m | Black Granite Brown Bluebell Fawn Dove Clay |
| FXT21 / AFT336 | Replaceable Tops PVC-u Top Aluminium Base | 2.50m | Black Granite Brown Bluebell Fawn Dove Clay |
| FXT21 / FXB339 | 400mm min curve on-site Replaceable Tops PVC-u Top PVC-u Base | 2.50m | Black Granite Brown Bluebell Fawn Dove Clay |
| FXT21 / AFT339 | Replaceable Tops PVC-u Top Aluminium Base | 2.50m | Black Granite Brown Bluebell Fawn Dove Clay |
| FXT21 / FXB3312 | 400mm min curve on-site Replaceable Tops PVC-u Top PVC-u Base | 2.50m | Black Granite Brown Bluebell Fawn Dove Clay |
| FXT21 / AFT3312 | Replaceable Tops PVC-u Top Aluminium Base | 2.50m | Black Granite Brown Bluebell Fawn Dove Clay |

Dimensions shown are nominal. Illustrations are 70% size in mm. Products subject to minor design alterations without notice.

Clip-Top fx®

| CODE / PROFILE | MATERIAL | LENGTH | COLOURS / FINISHES |
|----------------------------|--|--------|--|
| FXT31 / FXB336 | 400mm min curve on-site Replaceable Tops PVC-u Top PVC-u Base | 2.50m | Black Granite Brown Bluebell Fawn Dove Clay |
| FXT31 / AFT336 | Replaceable Tops PVC-u Top Aluminium Base | 2.50m | Black Granite Brown Bluebell Fawn Dove Clay |
| FXT31 / FXB339 | 400mm min curve on-site Replaceable Tops PVC-u Top PVC-u Base | 2.50m | Black Granite Brown Bluebell Fawn Dove Clay |
| FXT31 / AFT339 | Replaceable Tops PVC-u Top Aluminium Base | 2.50m | Black Granite Brown Bluebell Fawn Dove Clay |
| FXT31 / FXB3312 | 400mm min curve on-site Replaceable Tops PVC-u Top PVC-u Base | 2.50m | Black Granite Brown Bluebell Fawn Dove Clay |
| FXT31 / AFT3312 | Replaceable Tops PVC-u Top Aluminium Base | 2.50m | Black Granite Brown Bluebell Fawn Dove Clay |
| FXR40 / FXB336 | 400mm min convex curve on-site 900mm min concave Replaceable Tops PVC-u Top PVC-u Base | 2.50m | Black Granite Brown Bluebell Fawn Dove Clay |
| FXR40 / AFT336 | Replaceable Tops PVC-u Top Aluminium Base | 2.50m | Black Granite Brown Bluebell Fawn Dove Clay |

Dimensions shown are nominal. Illustrations are 70% size in mm. Products subject to minor design alterations without notice.



Design-Clip

Provides a neat finish at junctions between hard floors such as LVT, wood and wood laminate, whilst also allowing room for natural expansion. Our Design-Clip profiles are suitable for use within medium traffic environments including commercial offices, hotels and restaurants.

Installation Advice

- Bases should be fitted using cartridge adhesive and screw fixings.
- When installed with floorcoverings that require room for natural expansion, a suitable gap must be left between the profile base and the floorcovering to allow for that expansion.

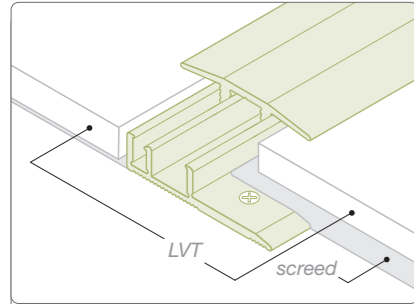

KC578 LVT to LVT.

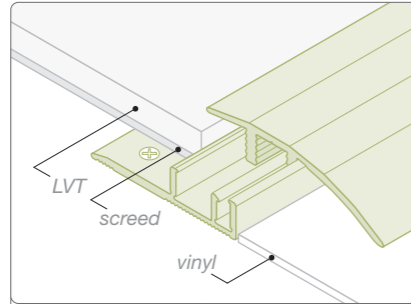

KA576 vinyl to LVT.

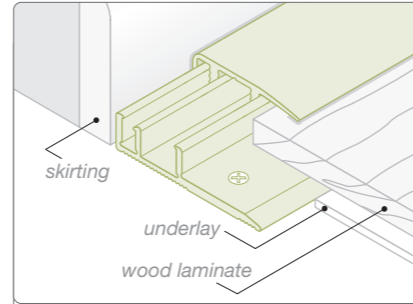

KB577 wood laminate to skirting.

| CODE / PROFILE | MATERIAL | LENGTH | COLOURS / FINISHES |
|------------------|---------------------------------|--------|--------------------|
| KA576 | Aluminium Top Aluminium Base | 2.70m | F4 Silver Anodised |
| KC578 | Aluminium Top Aluminium Base | 2.70m | F4 Silver Anodised |
| KB577 | Aluminium Top Aluminium Base | 2.70m | F4 Silver Anodised |

Dimensions shown are nominal. Illustrations are 70% size in mm. Products subject to minor design alterations without notice.

PPS® System

These two-piece profiles feature a unique patented linking screw enabling them to accommodate various heights of modular floorcoverings including LVT, whilst also allowing room for natural expansion where necessary. This range is ideal for use within medium traffic applications such as commercial offices and restaurants.

Installation Advice

- Bases should be fitted using cartridge adhesive and screw fixings.
- When installed with floorcoverings that require room for natural expansion, a suitable gap must be left between the profile base and the floorcovering to allow for that expansion.

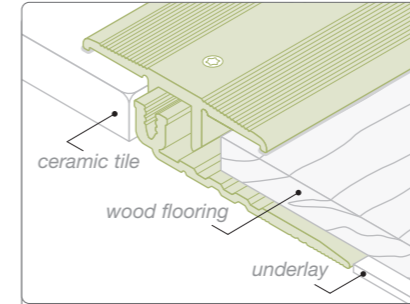

KC388AS ceramic tile to wood flooring.

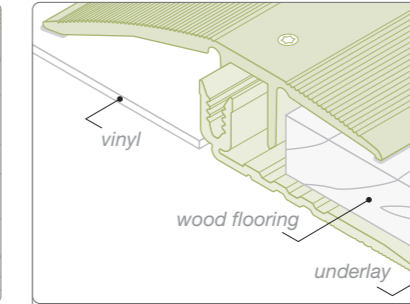

KA386XXL wood flooring to vinyl.

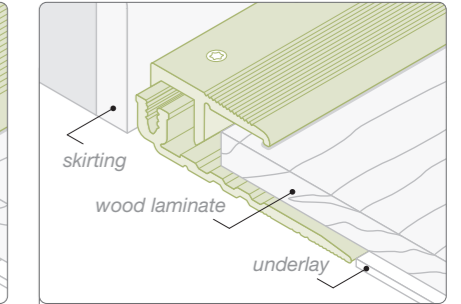

KB387AS wood laminate to skirting.

| CODE / PROFILE | MATERIAL | LENGTH | COLOURS / FINISHES |
|---------------------|---------------------------------|--------|--|
| KC388AS | Aluminium Top Aluminium Base | 2.70m | F4 Silver Anodised F5 Gold Anodised |
| KC388XXL | Aluminium Top Aluminium Base | 2.70m | F4 Silver Anodised F5 Gold Anodised |
| KA386AS | Aluminium Top Aluminium Base | 2.70m | F4 Silver Anodised F5 Gold Anodised |
| KA386XXL | Aluminium Top Aluminium Base | 2.70m | F4 Silver Anodised F5 Gold Anodised |
| KB387AS | Aluminium Top Aluminium Base | 2.70m | F4 Silver Anodised F5 Gold Anodised |
| KB387XXL | Aluminium Top Aluminium Base | 2.70m | F4 Silver Anodised F5 Gold Anodised |

Dimensions shown are nominal. Illustrations are 70% size in mm. Products subject to minor design alterations without notice.



NEW Mono-Clip® System

Mono-Clip is a range of two-piece profiles available in wood effect finishes for use with wood and wood laminates. Tops can be clipped into bases at varying heights to accommodate a variety of floorcoverings. Mono-Clip profiles are suitable for use within medium traffic applications such as commercial offices and restaurants.

Installation Advice

- Bases should be fitted using cartridge adhesive and screw fixings.
- When installed with floorcoverings that require room for natural expansion, a suitable gap must be left between the profile base and the floorcovering to allow for that expansion.

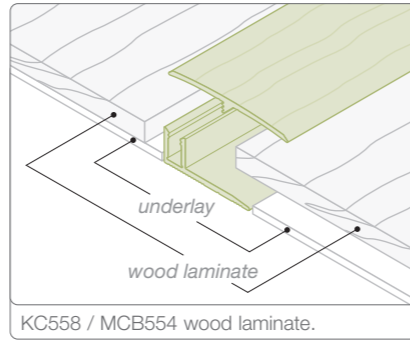
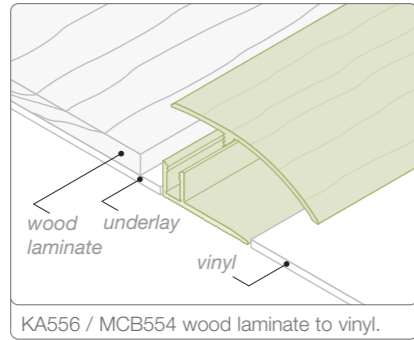
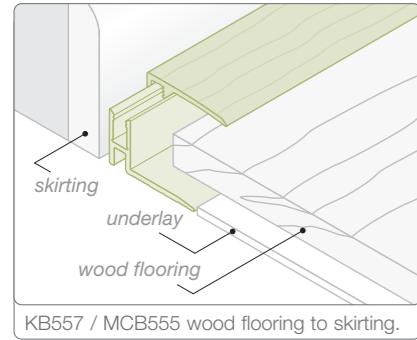

| CODE / PROFILE | MATERIAL | LENGTH | COLOURS / FINISHES |
|---------------------------|---------------------------------|--------|--|
| KC558 / MCB554 | Aluminium Top Aluminium Base | 2.70m | <ul style="list-style-type: none"> H30 Light Oak H61 Grey Oak H64 Cream Oak H65 Light Grey Oak H81 Walnut |
| KA556 / MCB554 | Aluminium Top Aluminium Base | 2.70m | <ul style="list-style-type: none"> H30 Light Oak H61 Grey Oak H64 Cream Oak H65 Light Grey Oak H81 Walnut |
| KB557 / MCB554 | Aluminium Top Aluminium Base | 2.70m | <ul style="list-style-type: none"> H30 Light Oak H61 Grey Oak H64 Cream Oak H65 Light Grey Oak H81 Walnut |
| KA556 / MCB555 | Aluminium Top Aluminium Base | 2.70m | <ul style="list-style-type: none"> H30 Light Oak H61 Grey Oak H64 Cream Oak H65 Light Grey Oak H81 Walnut |
| KB557 / MCB555 | Aluminium Top Aluminium Base | 2.70m | <ul style="list-style-type: none"> H30 Light Oak H61 Grey Oak H64 Cream Oak H65 Light Grey Oak H81 Walnut |
| KB557 / MCB554 | Aluminium Top Aluminium Base | 2.70m | <ul style="list-style-type: none"> H30 Light Oak H61 Grey Oak H64 Cream Oak H65 Light Grey Oak H81 Walnut |
| KB557 / MCB555 | Aluminium Top Aluminium Base | 2.70m | <ul style="list-style-type: none"> H30 Light Oak H61 Grey Oak H64 Cream Oak H65 Light Grey Oak H81 Walnut |

Dimensions shown are nominal. Illustrations are 70% size in mm. Products subject to minor design alterations without notice.

Trans-Edge® – Trims

Designed for the most demanding environments our Trans-Edge range is ideal where frequent heavy foot and wheeled traffic can be expected such as railway stations, airports and hospitals. Trans-Edge trims comprise an aluminium base channel with a choice of slip-resistant Elite inserts (ordered separately). Standard interior insert is available for interior dry conditions. Xtra-grip insert is available for interior areas that are at risk of becoming wet.

Installation Advice

- Aluminium channels are fixed using screws and cartridge adhesive. Elite insert is then fitted into channel to allow concealed fixings
- If used with carpet, compressed thickness of carpet should always be a tight fit to the internal gauge of the profile
- When installed with ceramics, wood or wood laminate flooring a suitable gap must be left between the profile and the flooring to allow for natural expansion
- Ramp profiles should always be fitted on top of resilient floorcoverings

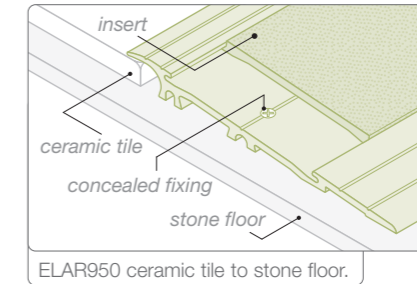
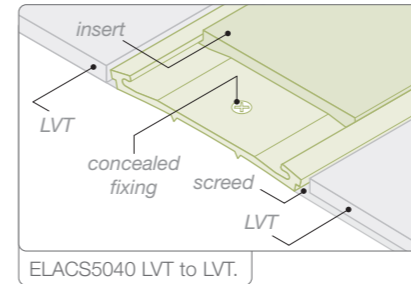

| Elite Insert supplied separately to channel | Coil Length |
|--|----------------|
| ELINS30 - Interior | 15m coil |
| ELINS40 - Interior | 25m coil |
| ELINS50 - Interior | 25m coil |
| ELINSXG30 - Xtra-grip | 15m coil |
| ELINSXG50 - Xtra-grip | 15m coil |

| CODE / PROFILE | MATERIAL | LENGTH | COLOURS / FINISHES |
|----------------------|--|--------------------------|--|
| ELACS5040 | Aluminium PVC-u Insert (ELINS40) | 2.50m See chart above | Elite Xtra-grip Insert ELINSXG All ELAR profiles |
| ELAR530 | Aluminium PVC-u Insert (ELINS30 or ELINSXG30) | 2.50m See chart above | <ul style="list-style-type: none"> Onyx Graphite Quarry Ochre |
| ELAR830 | Aluminium PVC-u Insert (ELINS30 or ELINSXG30) | 2.50m See chart above | Elite Interior Insert ELINS All ELAR & ELACS profiles |
| ELAR950 | Aluminium PVC-u Insert (ELINS50 or ELINSXG50) | 2.50m See chart above | <ul style="list-style-type: none"> Jet Coffee Lead Steel Snowdrift |
| ELAR1250 | Aluminium PVC-u Insert (ELINS50 or ELINSXG50) | 2.50m See chart above | ELACS5040 ELAR950 ELAR1250 ELAR1550 also available with |
| ELAR1550 | Aluminium PVC-u Insert (ELINS50 or ELINSXG50) | 2.50m See chart above | <ul style="list-style-type: none"> Ink Burgundy Midnight Evergreen Ocean Poppy Cloud Linen Glacier Canvas Buttercup |
| ELAR1830 | Aluminium PVC-u Insert (ELINS30 or ELINSXG30) | 2.50m See chart above | |

Dimensions shown are nominal. Illustrations are 70% size in mm. Products subject to minor design alterations without notice.



Edge Trims

Our Edge Trims are compatible with a huge variety of flooring types including LVT, wood laminate and carpet tile, providing a neat joint between floorcoverings.

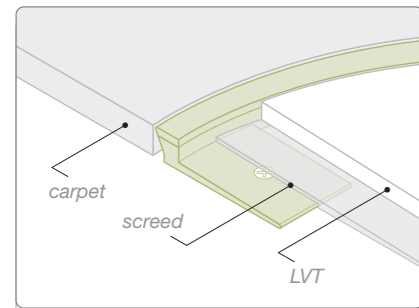

GT61 carpet to LVT.

Key

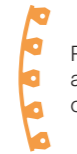

Pre-punched with tabs and fixing holes for on-site curving.



Solid base for straights.



Solid base with countersunk holes for straights.

| CODE / PROFILE | MATERIAL | LENGTH | COLOURS / FINISHES |
|-------------------|-----------------------|--------|---|
| TA6 | Aluminium | 2.75m | Mill Finish |
| TA8 | Aluminium | 3.00m | Mill Finish |
| ET367 | Aluminium | 2.70m | F3 Polished F4 Silver Anodised |
| GT61M | pvc Top PVC-u Base | 2.50m | <ul style="list-style-type: none"> Burnt Almond Zinc Doubloon Platinum Silver |
| GT61R | pvc Top PVC-u Base | 2.50m | <ul style="list-style-type: none"> Black Brown Granite Bluebell Dove Clay |
| PET276 | pvc Top PVC-u Base | 2.50m | <ul style="list-style-type: none"> Black Brown Granite Dove |

GT/PET profile bases contain up to 25% recycled content.

Dimensions shown are nominal. Illustrations are 70% size in mm. Products subject to minor design alterations without notice.

Nap Trims

Typically used when joining carpet, carpet tile or traditional carpet with underlay to a hard floorcovering such as LVT, wood laminate or ceramics. Nap Trims allow the edges of the carpet to be concealed, resulting in a neat finish whilst also protecting the raw edges.

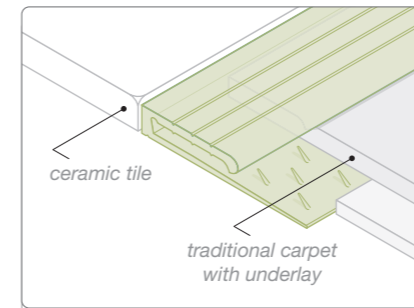

CG1042 ceramic tile to carpet.

Key



Solid base for straights.

| CODE / PROFILE | MATERIAL | LENGTH | COLOURS / FINISHES |
|-------------------|---|-------------------------|--------------------|
| ANT27 | Aluminium | 2.44m 2.75m 3.20m | Mill Finish |
| ANT355 | Aluminium Available with or without carpet gripper | 2.44m 2.75m 3.20m | Mill Finish |
| CG1042 | Aluminium Available with or without carpet gripper | 2.44m 2.75m 3.20m | Mill Finish |
| BCT16 | Bronze Available with or without carpet gripper | 2.50m 2.75m 3.20m | Polished |
| BCT18 | Bronze Available with or without carpet gripper | 2.50m 2.75m 3.20m | Polished |

Dimensions shown are nominal. Illustrations are 70% size in mm. Products subject to minor design alterations without notice.



Square Edge Trims

Useful for hiding any slight imperfections in joints or cuts, these profiles are compatible for use with a variety of modular flooring types including LVT, carpet tile, wood and wood laminate at a junction with other flooring materials such as carpet, ceramics and wood. We supply selected profiles with pre-punched bases and tabs for on-site curving as indicated below.

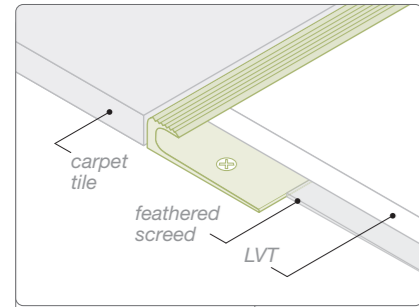

ET804 carpet tile to LVT.

Key

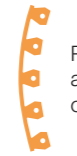

Pre-punched with tabs and fixing holes for on-site curving.



Solid base for straights.



Solid base with countersunk holes for straights.

| CODE / PROFILE | MATERIAL | LENGTH | COLOURS / FINISHES |
|----------------|-----------|--------|-----------------------------------|
| ET804 | Aluminium | 2.50m | F3 Polished F4 Silver Anodised |
| ET804EBF4 | Aluminium | 2.50m | F4 Silver Anodised |
| ET806 | Aluminium | 2.50m | F3 Polished F4 Silver Anodised |
| ET806EBF4 | Aluminium | 2.50m | F4 Silver Anodised |

Dimensions shown are nominal. Illustrations are 70% size in mm. Products subject to minor design alterations without notice.

Square Edge Trims

| CODE / PROFILE | MATERIAL | LENGTH | COLOURS / FINISHES |
|----------------|-----------|--------|-----------------------------------|
| ET805 | Aluminium | 2.50m | F3 Polished F4 Silver Anodised |
| ET805EBF4 | Aluminium | 2.50m | F4 Silver Anodised |
| ACT48 | Aluminium | 3.20m | Mill Finish |
| ET210 | Aluminium | 2.70m | F3 Polished F4 Silver Anodised |
| ET210EBF4 | Aluminium | 2.70m | F4 Silver Anodised |
| ET212 | Aluminium | 2.70m | F3 Polished F4 Silver Anodised |
| ET212EBF4 | Aluminium | 2.70m | F4 Silver Anodised |

Dimensions shown are nominal. Illustrations are 70% size in mm. Products subject to minor design alterations without notice.



Finishing Trims

Used to form a neat and clean finish to the edge of a floorcovering where it either finishes or meets another floorcovering. Finishing trims protect the raw edge of floorcoverings, thus extending the life of the floorcovering. In addition, they ensure a safe transition and prevent the edge of the floorcovering from becoming a trip hazard.

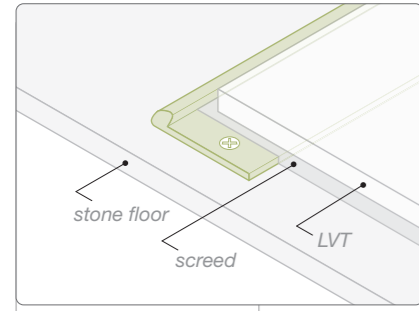

ET356 stone floor to LVT.

Key



Pre-punched with tabs and fixing holes for on-site curving.



Solid base for straights.



Solid base with countersunk holes for straights.

| CODE / PROFILE | MATERIAL | LENGTH | COLOURS / FINISHES |
|----------------------|-----------|--------|---------------------------------------|
| ACT61 | Aluminium | 2.50m | ■ Mill Finish |
| ACT81 | Aluminium | 2.50m | ■ Mill Finish |
| ET356 | Aluminium | 2.50m | ■ F3 Polished ■ F4 Silver Anodised |
| ET356EBF4 | Aluminium | 2.50m | ■ F4 Silver Anodised |
| ET359 | Aluminium | 2.50m | ■ F3 Polished ■ F4 Silver Anodised |
| ET359EBF4 | Aluminium | 2.50m | ■ F4 Silver Anodised |

Dimensions shown are nominal. Illustrations are 70% size in mm. Products subject to minor design alterations without notice.

Joint Trims

Provide a neat junction between two floorcoverings of the same height, for instance where a wood effect LVT meets a mineral effect LVT. These profiles also protect the edges of the floorcoverings and provide a safe transition. Profiles are available pre-drilled with countersunk fixing holes or pre-punched with tabs and fixing holes for on-site curving as indicated below.

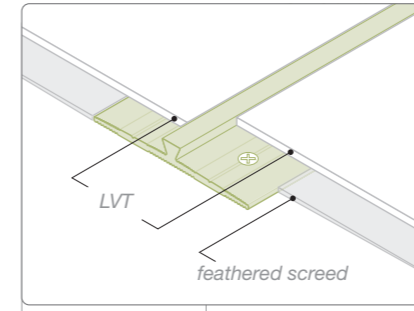

JT365 LVT to LVT.

Key



Pre-punched with tabs and fixing holes for on-site curving.



Solid base with countersunk holes for straights.

| CODE / PROFILE | MATERIAL | LENGTH | COLOURS / FINISHES |
|----------------------|-----------|--------|---------------------------------------|
| JT365 | Aluminium | 3.00m | ■ F3 Polished ■ F4 Silver Anodised |
| JT365EBF4 | Aluminium | 3.00m | ■ F4 Silver Anodised |
| JT366 | Aluminium | 2.70m | ■ F3 Polished ■ F4 Silver Anodised |
| JT366EBF4 | Aluminium | 2.70m | ■ F4 Silver Anodised |

Dimensions shown are nominal. Illustrations are 70% size in mm. Products subject to minor design alterations without notice.



Threshold Trims

Commonly used at door interfaces or when defining changes in areas, our range of Threshold Trims are suitable for use with floorcoverings of the same height or slightly differing heights, creating a neat finish.

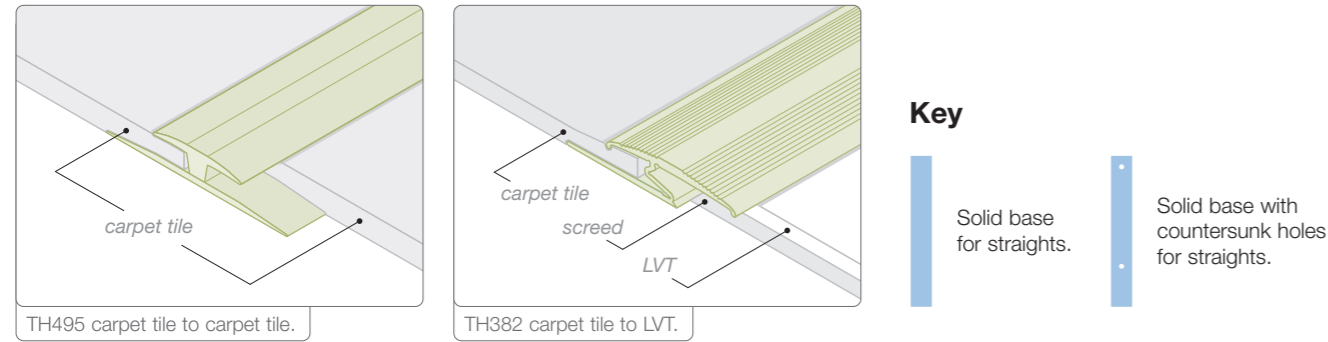

| CODE / PROFILE | MATERIAL | LENGTH | COLOURS / FINISHES |
|---|-----------------------|--------|---|
| TH382 | Aluminium | 2.70m | <ul style="list-style-type: none"> F3 Polished F4 Silver Anodised |
| <p>Folding points</p> <p>TH382 and TH383 - the top section should be lightly dressed down using a rubber mallet after installation to ensure a tight fit to edges of both floorcoverings.</p> | | | |
| TH383 | Aluminium | 2.70m | <ul style="list-style-type: none"> F3 Polished F4 Silver Anodised |
| TH495 | pvc Top PVC-u Base | 2.50m | <ul style="list-style-type: none"> Zinc Doublon Platinum Silver |
| CET5 | pvc | 2.00m | <ul style="list-style-type: none"> Black Brown Granite Bluebell Dove Clay |

Dimensions shown are nominal. Illustrations are 70% size in mm. Products subject to minor design alterations without notice.

Transition T Profiles

Designed for joining floorcoverings of the same, or slightly differing, heights, our Transition T profiles allow any slight imperfections to the joints and cuts to be hidden. They allow a gap for natural expansion and can also be curved on-site using a bending machine for shaped edges. To rent, buy or for more information about bending machines, please contact our Technical Support department on 01625 428922. An additional benefit of this range is that it can be fitted after the floorcoverings have already been installed, making these an ideal solution where different trades have installed each floorcovering, e.g. ceramics contractors and flooring contractors.

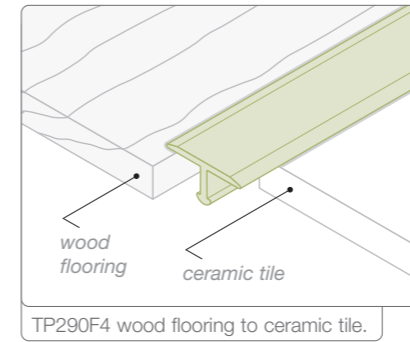

| CODE / PROFILE | MATERIAL | LENGTH | COLOURS / FINISHES |
|--|-----------|--------|--------------------|
| TP290F4 <p>Bending machine required see page 6</p> | Aluminium | 2.70m | F4 Silver Anodised |
| TP290F7 <p>Bending machine required see page 6</p> | Brass | 2.70m | F7 Polished |
| TP291F4 <p>Bending machine required see page 6</p> | Aluminium | 2.70m | F4 Silver Anodised |
| TP295F4 <p>Bending machine required see page 6</p> | Aluminium | 2.70m | F4 Silver Anodised |
| TP293F4 <p>Bending machine required see page 6</p> | Aluminium | 2.70m | F4 Silver Anodised |

Dimensions shown are nominal. Illustrations are 70% size in mm. Products subject to minor design alterations without notice.



Ramp Edges – Pvc & Aluminium

Ideal for joining a variety of floorcoverings ranging from LVT, woods or carpet tile to floorcoverings of a lower height such as stone, concrete or resilient flooring. Our Ramp Edge profiles ensure a safe transition between floorcoverings and protect the edges to minimise the risk of damage.

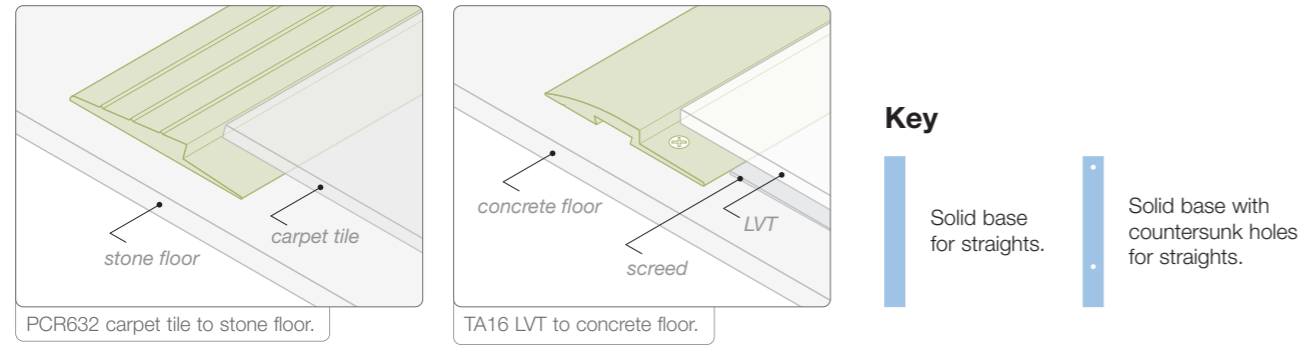

Pvc:

| CODE / PROFILE | MATERIAL | LENGTH | COLOURS / FINISHES |
|-------------------|----------|--------|---|
| CVT5 | pvc | 2.00m | <ul style="list-style-type: none"> Black Brown Granite Dove |
| CTR5 | pvc | 2.00m | <ul style="list-style-type: none"> Black Brown Granite Dove |
| PCR632 | pvc | 2.00m | <ul style="list-style-type: none"> Black Brown Granite Dove |
| PCR932 | pvc | 2.00m | <ul style="list-style-type: none"> Black Brown Granite Dove |
| T450 | pvc | 2.00m | <ul style="list-style-type: none"> Black Brown Granite Dove |
| T600 | pvc | 2.00m | <ul style="list-style-type: none"> Black Brown Granite Dove |

Dimensions shown are nominal. Illustrations are 70% size in mm. Products subject to minor design alterations without notice.

Ramp Edges – Pvc & Aluminium

Aluminium:

| CODE / PROFILE | MATERIAL | LENGTH | COLOURS / FINISHES |
|-------------------|-----------|--------|---|
| RT264 | Aluminium | 2.70m | <ul style="list-style-type: none"> F3 Polished F4 Silver Anodised |
| RT265 | Aluminium | 2.70m | <ul style="list-style-type: none"> F3 Polished F4 Silver Anodised |
| TA16 | Aluminium | 2.75m | <ul style="list-style-type: none"> Mill Finish |
| RT330 | Aluminium | 2.70m | <ul style="list-style-type: none"> F3 Polished F4 Silver Anodised |
| RT250S | Aluminium | 2.70m | <ul style="list-style-type: none"> F3 Polished F4 Silver Anodised |
| RT247 | Aluminium | 2.70m | <ul style="list-style-type: none"> F3 Polished F4 Silver Anodised |
| RT245 | Aluminium | 2.70m | <ul style="list-style-type: none"> F3 Polished F4 Silver Anodised |

Dimensions shown are nominal. Illustrations are 70% size in mm. Products subject to minor design alterations without notice.



Multi-Purpose Trims

Our collection of Multi-Purpose Trims offers incredible versatility with a wide selection of sizes available to suit floorcoverings ranging from LVT to wood flooring.

Featuring a reduced visible surface, these profiles are ideal for areas where a clean, subtle transition is required, allowing the trim to blend in with the surrounding environment and floorcoverings.

A choice of aluminium, stainless steel and brass finishes are available, allowing you to choose a trim that best suits your particular application.

We offer three base options, which are highlighted next to each profile by the relevant symbol (symbol key can be found on page 32):

- Solid base suitable for straights.
- Pre-punched base with tabs and fixing holes for on-site curving.
- Perforated base with fixing holes for straights and use with ceramics.

ETR303F0

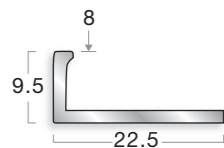

Gradus ETR303F0 Multi-Purpose Trim creating a safe transition between LVT and ceramic tile.



Multi-Purpose Trims

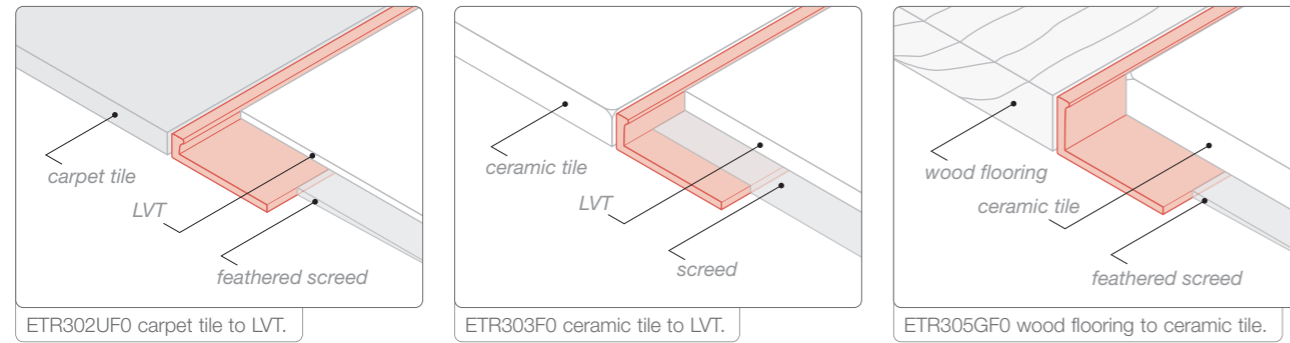

Key

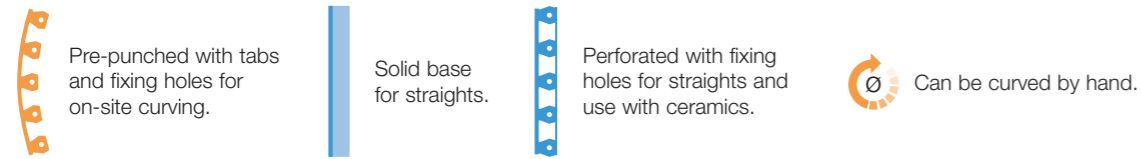

Aluminium:

| CODE / PROFILE | MATERIAL | LENGTH | COLOURS / FINISHES |
|----------------|-----------|--------|--------------------|
| ETR299F0 | Aluminium | 2.50m | F0 Natural |
| ETR299UF0 | Aluminium | 2.50m | F0 Natural |
| ETR299GF0 | Aluminium | 2.50m | F0 Natural |
| ETR300F0 | Aluminium | 2.50m | F0 Natural |
| ETR300UF0 | Aluminium | 2.50m | F0 Natural |

Dimensions shown are nominal. Illustrations are 70% size in mm. Products subject to minor design alterations without notice.





Multi-Purpose Trims

| CODE / PROFILE | MATERIAL | LENGTH | COLOURS / FINISHES |
|----------------|-----------|--------|--------------------|
| ETR300GF0 | Aluminium | 2.50m | F0 Natural |
| ETR301F0 | Aluminium | 2.50m | F0 Natural |
| ETR301UF0 | Aluminium | 2.50m | F0 Natural |
| ETR301GF0 | Aluminium | 2.50m | F0 Natural |
| ETR302F0 | Aluminium | 2.50m | F0 Natural |
| ETR302UF0 | Aluminium | 2.50m | F0 Natural |
| ETR302GF0 | Aluminium | 2.50m | F0 Natural |
| ETR307F0 | Aluminium | 2.50m | F0 Natural |

Dimensions shown are nominal. Illustrations are 70% size in mm. Products subject to minor design alterations without notice. Symbol key - page 32.

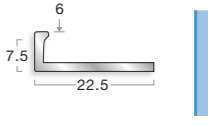
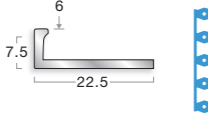

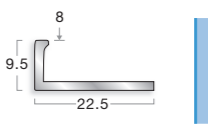
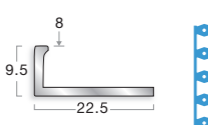

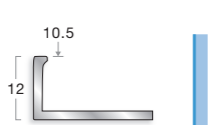

Multi-Purpose Trims

| CODE / PROFILE | MATERIAL | LENGTH | COLOURS / FINISHES |
|---|-----------|--------|--------------------|
| ETR307UF0  | Aluminium | 2.50m | ■ F0 Natural |
| ETR307GF0  | Aluminium | 2.50m | ■ F0 Natural |
| ETR303F0  | Aluminium | 2.50m | ■ F0 Natural |
| ETR303UF0  | Aluminium | 2.50m | ■ F0 Natural |
| ETR303GF0  | Aluminium | 2.50m | ■ F0 Natural |
| ETR304F0  | Aluminium | 2.50m | ■ F0 Natural |
| ETR304UF0  | Aluminium | 2.50m | ■ F0 Natural |

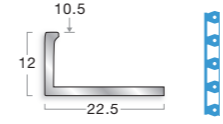
Dimensions shown are nominal. Illustrations are 70% size in mm. Products subject to minor design alterations without notice. Symbol key - page 32.

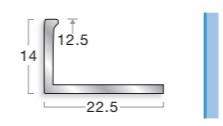
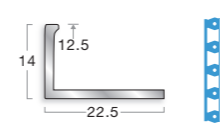
Multi-Purpose Trims

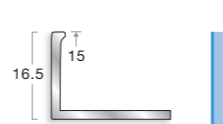
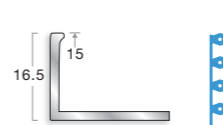
| CODE / PROFILE | MATERIAL | LENGTH | COLOURS / FINISHES |
|---|-----------|--------|--------------------|
| ETR304GF0  | Aluminium | 2.50m | ■ F0 Natural |
| ETR305F0  | Aluminium | 2.50m | ■ F0 Natural |
| ETR305UF0  | Aluminium | 2.50m | ■ F0 Natural |
| ETR305GF0  | Aluminium | 2.50m | ■ F0 Natural |
| ETR306F0  | Aluminium | 2.50m | ■ F0 Natural |
| ETR306UF0  | Aluminium | 2.50m | ■ F0 Natural |
| ETR306GF0  | Aluminium | 2.50m | ■ F0 Natural |

Dimensions shown are nominal. Illustrations are 70% size in mm. Products subject to minor design alterations without notice. Symbol key - page 32.



Multi-Purpose Trims

| CODE / PROFILE | MATERIAL | LENGTH | COLOURS / FINISHES |
|----------------------|-----------|--------|--------------------|
| ETR312F0 | Aluminium | 2.50m | F0 Natural |
| ETR312UF0 | Aluminium | 2.50m | F0 Natural |
| ETR312GF0 | Aluminium | 2.50m | F0 Natural |
| ETR309F0 | Aluminium | 2.50m | F0 Natural |
| ETR309UF0 | Aluminium | 2.50m | F0 Natural |
| ETR309GF0 | Aluminium | 2.50m | F0 Natural |

Dimensions shown are nominal. Illustrations are 70% size in mm. Products subject to minor design alterations without notice. Symbol key - page 32.

Multi-Purpose Trims

Stainless Steel:

| CODE / PROFILE | MATERIAL | LENGTH | COLOURS / FINISHES |
|----------------------|-----------------|--------|--------------------|
| ETR301GF8 | Stainless Steel | 2.50m | F8 Polished |
| ETR302GF8 | Stainless Steel | 2.50m | F8 Polished |
| ETR307GF8 | Stainless Steel | 2.50m | F8 Polished |
| ETR303GF8 | Stainless Steel | 2.50m | F8 Polished |
| ETR304GF8 | Stainless Steel | 2.50m | F8 Polished |
| ETR305GF8 | Stainless Steel | 2.50m | F8 Polished |
| ETR306GF8 | Stainless Steel | 2.50m | F8 Polished |
| ETR309GF8 | Stainless Steel | 2.50m | F8 Polished |

▲ Note there is a +/- 0.5mm tolerance on the height of stainless steel multi-purpose trims.

Dimensions shown are nominal. Illustrations are 70% size in mm. Products subject to minor design alterations without notice. Symbol key - page 32.



Multi-Purpose Trims

Brass:

| CODE / PROFILE | MATERIAL | LENGTH | COLOURS / FINISHES |
|----------------|----------|--------|--------------------|
| ETR301F7 | Brass | 2.50m | F7 Polished |
| ETR301GF7 | Brass | 2.50m | F7 Polished |
| ETR302F7 | Brass | 2.50m | F7 Polished |
| ETR302GF7 | Brass | 2.50m | F7 Polished |
| ETR307F7 | Brass | 2.50m | F7 Polished |
| ETR307GF7 | Brass | 2.50m | F7 Polished |
| ETR303F7 | Brass | 2.50m | F7 Polished |
| ETR303GF7 | Brass | 2.50m | F7 Polished |

Dimensions shown are nominal. Illustrations are 70% size in mm. Products subject to minor design alterations without notice. Symbol key - page 32.

Multi-Purpose Trims

| CODE / PROFILE | MATERIAL | LENGTH | COLOURS / FINISHES |
|----------------|----------|--------|--------------------|
| ETR304F7 | Brass | 2.50m | F7 Polished |
| ETR304GF7 | Brass | 2.50m | F7 Polished |
| ETR305F7 | Brass | 2.50m | F7 Polished |
| ETR305GF7 | Brass | 2.50m | F7 Polished |
| ETR306F7 | Brass | 2.50m | F7 Polished |
| ETR306GF7 | Brass | 2.50m | F7 Polished |
| ETR309F7 | Brass | 2.50m | F7 Polished |
| ETR309GF7 | Brass | 2.50m | F7 Polished |

Dimensions shown are nominal. Illustrations are 70% size in mm. Products subject to minor design alterations without notice. Symbol key - page 32.



Cover Strips

Our collection of Cover Strips are designed for joining floorcoverings of a similar thickness and are typically used at door thresholds where two floorcoverings meet.

Not only do they ensure a neat and safe junction between floorcoverings, but they also help to protect the exposed edges of the floorcoverings from damage.

A variety of Cover Strips are available with a choice of central or side-drilled countersunk fixing holes. AJC profiles offer superb flexibility and can also be used as expansion joint covers where required.

Profiles are available in a selection of materials including stainless steel, brass and aluminium, complemented by a great choice of finishes including mill, matt, silver anodised or polished to suit your specific needs.



SCSM451

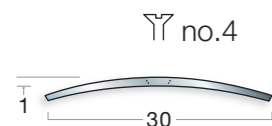

Gradus SCSM451 Cover Strip
providing a safe and neat join
between two types of LVT.

Cover Strips

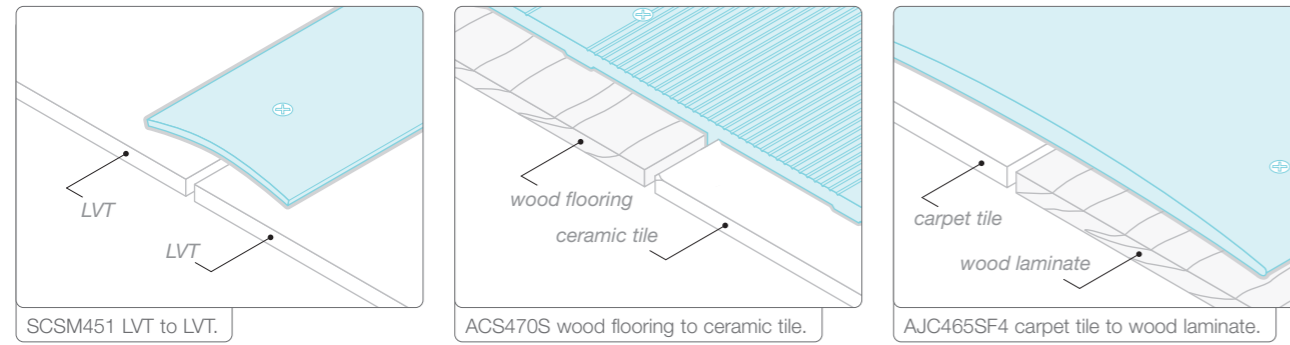

Key

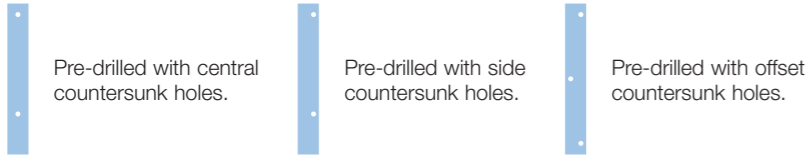

Stainless Steel:

| CODE / PROFILE | MATERIAL | LENGTH | COLOURS / FINISHES |
|----------------|-----------------|--------|--------------------|
| SCSM471 | Stainless Steel | 2.70m | F8G Matt |
| SCSP471 | Stainless Steel | 2.70m | F8 Polished |
| SCS471SF8G | Stainless Steel | 2.70m | F8G Matt |
| SCS471SF8 | Stainless Steel | 2.70m | F8 Polished |
| SCSM451 | Stainless Steel | 2.70m | F8G Matt |

Dimensions shown are nominal. Illustrations are 70% size in mm. Products subject to minor design alterations without notice.

Cover Strips

| CODE / PROFILE | MATERIAL | LENGTH | COLOURS / FINISHES |
|----------------|-----------------|--------|--------------------|
| SCSP451 | Stainless Steel | 2.70m | F8 Polished |
| SCS451SF8G | Stainless Steel | 2.70m | F8G Matt |
| SCS451SF8 | Stainless Steel | 2.70m | F8 Polished |
| SCSM454 | Stainless Steel | 2.70m | F8G Matt |
| SCSP454 | Stainless Steel | 2.70m | F8 Polished |
| SCS454SF8G | Stainless Steel | 2.70m | F8G Matt |
| SCS454SF8 | Stainless Steel | 2.70m | F8 Polished |
| SCSM455 | Stainless Steel | 2.70m | F8G Matt |
| SCSP455 | Stainless Steel | 2.70m | F8 Polished |

Dimensions shown are nominal. Illustrations are 70% size in mm. Products subject to minor design alterations without notice.

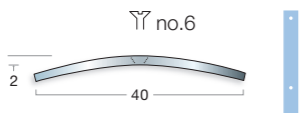
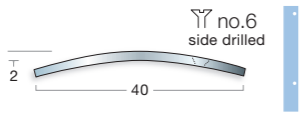
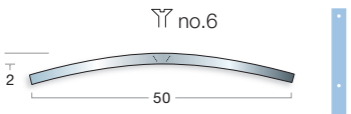
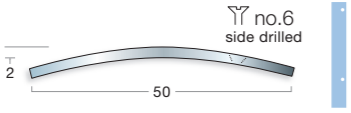

Cover Strips

| CODE / PROFILE | MATERIAL | LENGTH | COLOURS / FINISHES |
|--|-----------------|--------|--------------------|
| SCSM474  | Stainless Steel | 2.70m | F8G Matt |
| SCS474SF8G  | Stainless Steel | 2.70m | F8G Matt |
| SCSM475  | Stainless Steel | 2.70m | F8G Matt |
| SCS475SF8G  | Stainless Steel | 2.70m | F8G Matt |

Brass:

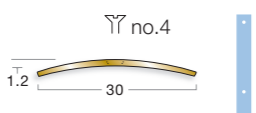
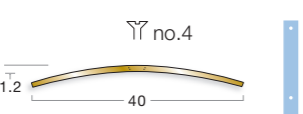
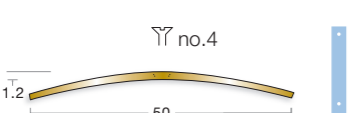
| CODE / PROFILE | MATERIAL | LENGTH | COLOURS / FINISHES |
|---|----------|--------|--------------------|
| BCS452F7  | Brass | 2.70m | F7 Polished |
| BCS454F7  | Brass | 2.70m | F7 Polished |
| BCS455F7  | Brass | 2.70m | F7 Polished |

Dimensions shown are nominal. Illustrations are 70% size in mm. Products subject to minor design alterations without notice.

Cover Strips

Aluminium:

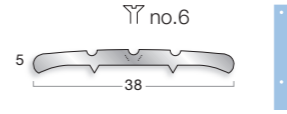
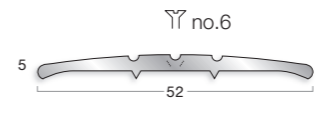
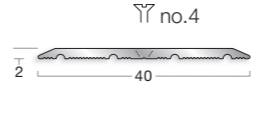
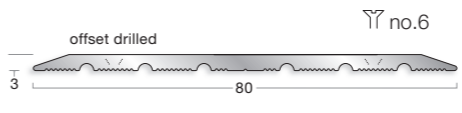
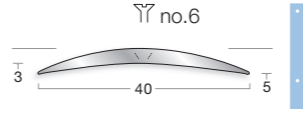
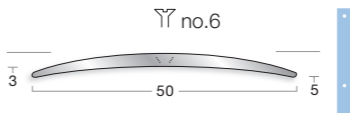
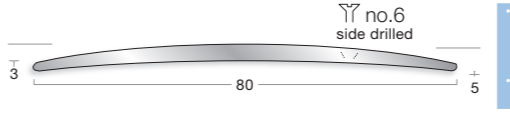
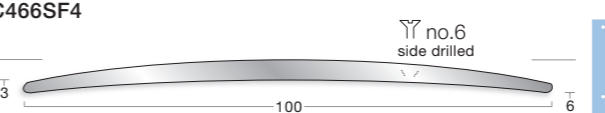
| CODE / PROFILE | MATERIAL | LENGTH | COLOURS / FINISHES |
|---|-----------|----------------|-----------------------------------|
| ACS38  | Aluminium | 2.50m 2.75m | Mill Finish |
| ACS52  | Aluminium | 2.50m 2.75m | Mill Finish |
| ACS441  | Aluminium | 2.70m | F3 Polished F4 Silver Anodised |
| ACS444  | Aluminium | 2.70m | F3 Polished F4 Silver Anodised |
| ACS462F3  | Aluminium | 2.70m | F3 Polished |
| ACS463F3  | Aluminium | 2.70m | F3 Polished |
| AJC465SF4  ideal for use as an expansion joint cover to allow movement | Aluminium | 2.70m | F4 Silver Anodised |
| AJC466SF4  ideal for use as an expansion joint cover to allow movement | Aluminium | 2.70m | F4 Silver Anodised |
| ACS470S See below | Aluminium | 3.00m | F3 Polished F4 Silver Anodised |

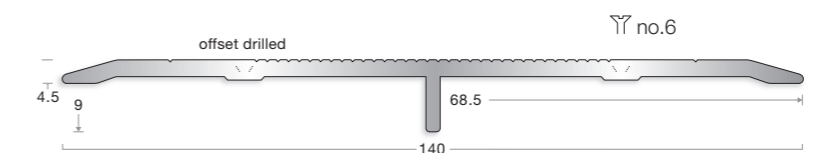

Dimensions shown are nominal. Illustrations are 70% size in mm. Products subject to minor design alterations without notice.



Skirting & Coving

Our skirting & cove formers provide a neat, clean and safe solution for junctions where the floor meets the wall. Gradus profiles are the perfect complement for any LVT and other types of modular floorcoverings such as woods, ceramics and carpet tile.

Below are a variety of considerations to help ensure that you select the appropriate skirting or coving profile for the job at hand.

What to consider when selecting a Skirting or Coving?

- The type of environment?
- The type of floorcovering(s) and the thickness of these?
- Is there a requirement for the floorcovering to continue up the wall?
- Any additional functionality requirements such as concealing cables?
- Number of end caps, junctions, external or internal corners and any other accessories required?
 - Is “wall-to-floor expansion” necessary?
- What specific look are you intending to achieve?
- Does the skirting ideally need to sit on top of the floorcovering?
 - Is there a particular colour or finish required?

Colour Availability

| | MAS90 Range | MAS95 Range | MAS97 Range | MSS790 Range | CVA870IW | CVA927 |
|------------------------------|-------------|-------------|-------------|--------------|----------|--------|
| F4 Silver Anodised Aluminium | | | | | • | • |
| Silver Anodised Aluminium | • | • | • | | | |
| F6 Bronze Anodised Aluminium | | | | | • | |
| F9 Sand Anodised Aluminium | | | | | • | |
| Satin Stainless Steel | | | | • | | |

F4 Silver Anodised Aluminium



Silver Anodised Aluminium



F6 Bronze Anodised Aluminium



F9 Sand Anodised Aluminium



Satin Stainless Steel



Please note: Due to the limitations of the printing process, colours within this catalogue should not be relied upon for colour matching. An accurate colour match can only be achieved by requesting the relevant product sample(s) from Gradus Technical Support on 01625 428922.

Skirting & Coving

| | |
|---|----|
| MAS90 Aluminium Skirtings | 48 |
| MSS790 Stainless Steel Skirtings | 49 |
| MAS95 Interlocking Aluminium Skirtings..... | 50 |
| MAS97 Interlocking Aluminium Skirting..... | 51 |
| Aluminium Cove Formers | 52 |

Gradus MAS90/10SF metal skirting installed with LVT.

MAS90 Aluminium Skirtings



These silver anodised aluminium profiles create a modern hi-tech finish and are designed to sit on top of floorcoverings. The capped toe design makes them a great solution for hiding wall-to-floor expansion gaps.

A selection of metal accessories including end caps, junctions and corners are also available for our MAS90 profiles, all supplied in a silver anodised finish to ensure neat and tidy finishing on site.

MAS90 profiles are fixed to the wall using appropriate adhesive.

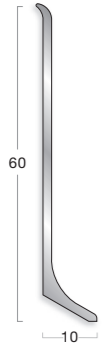
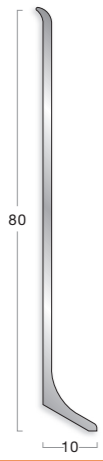
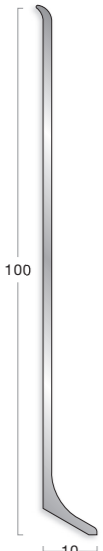
| CODE / PROFILE | FINISHES | LENGTH | END CAPS | JUNCTION | EXTERNAL CORNER | INTERNAL CORNER |
|---|-----------------------------|--------|------------|------------|-----------------|-----------------|
| MAS90/6SF  | Silver Anodised Aluminium * | 2.00m | MAS90/6MP | MAS90/6MG | MAS90/6ME | MAS90/6MI |
| MAS90/8SF  | Silver Anodised Aluminium * | 2.00m | MAS90/8MP | MAS90/8MG | MAS90/8ME | MAS90/8MI |
| MAS90/10SF  | Silver Anodised Aluminium * | 2.00m | MAS90/10MP | MAS90/10MG | MAS90/10ME | MAS90/10MI |

* Note: Additional finishes are available on request subject to minimum quantities and lead times.

All accessories are supplied in packs of 4 except for End Caps which are supplied as 4 sets of 2 (one left hand and one right hand).

MSS790 Stainless Steel Skirtings

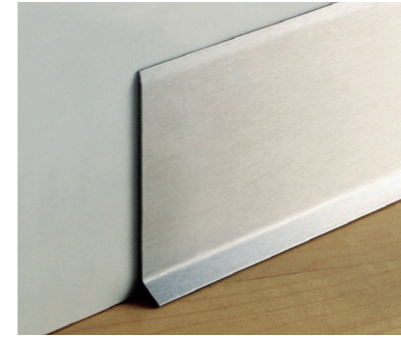

Featuring a stainless steel satin finish, this range is ideal for use in areas where a modern hi-tech finish is required. Designed to sit on top of a variety of floorcoverings, the capped toe design allows wall-to-floor expansion gaps to be hidden.

A choice of metal accessories including end caps, junctions and corners are also available in a satin finish for a consistent look.

MSS790 profiles are fixed to the wall using appropriate adhesive.

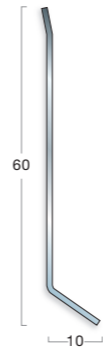
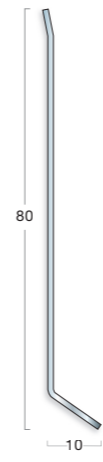
| CODE / PROFILE | FINISHES | LENGTH | END CAPS | JUNCTION | EXTERNAL CORNER | INTERNAL CORNER |
|---|------------------------------|--------|-------------|-------------|-----------------|-----------------|
| MSS790/6SF  | Stainless Steel Satin Finish | 2.70m | MSS790/6MPS | MSS790/6MGS | MSS790/6MES | MSS790/6MIS |
| MSS790/8SF  | Stainless Steel Satin Finish | 2.70m | MSS790/8MPS | MSS790/8MGS | MSS790/8MES | MSS790/8MIS |

All accessories are supplied in packs of 4 except for End Caps which are supplied as 4 sets of 2 (one left hand and one right hand).

Dimensions shown are nominal. Illustrations are 70% size in mm. Products subject to minor design alterations without notice.



MAS95 Interlocking Aluminium Skirtings

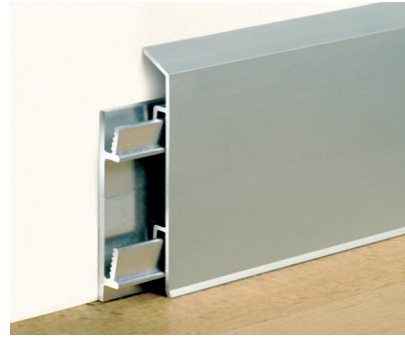

Ideal for use in areas where a modern finish is required, these silver anodised aluminium profiles feature interlocking aluminium brackets and are suitable for most types of modular floorcoverings including LVT, carpet tile, wood, wood laminate and ceramic tiles. The design allows low voltage cables for computers or telephones to be concealed behind the skirting profile and out of view for a clean look.

We offer a variety of accessories such as end caps, junctions and corners in a silver finish PVC-u to co-ordinate with our MAS95 profiles.

MAS95 profiles are fixed to the wall using screw fixings.

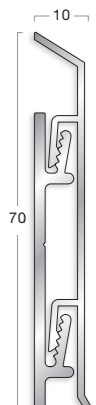
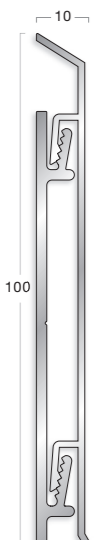
| CODE / PROFILE | FINISHES | LENGTH | END CAPS | JUNCTION | EXTERNAL CORNER | INTERNAL CORNER |
|---|---|---------|-----------|-----------|-----------------|-----------------|
| MAS95/7SF | Silver Anodised Aluminium with interlocking aluminium fixing brackets | 2.00m * | MAS95/7P | MAS95/7G | MAS95/7E | MAS95/7I |
|  | | | | | | |
| MAS95/10SF | Silver Anodised Aluminium with interlocking aluminium fixing brackets | 2.00m * | MAS95/10P | MAS95/10G | MAS95/10E | MAS95/10I |
|  | | | | | | |

* Note: 3 fixing brackets supplied per length.

All accessories are supplied in packs of 4 except for End Caps which are supplied as 4 sets of 2 (one left hand and one right hand).

Dimensions shown are nominal. Illustrations are 70% size in mm. Products subject to minor design alterations without notice.

MAS97 Interlocking Aluminium Skirting

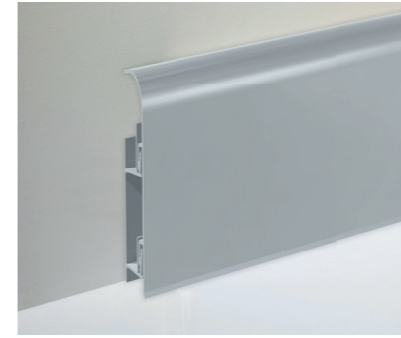

Suitable for use in areas where a modern finish is required, the MAS97 range features a silver anodised aluminium finish to complement a range of modular floorcoverings including LVT, carpet tiles, wood, wood laminate and ceramic tiles. Designed with interlocking aluminium brackets, these profiles are ideal for use within applications where low voltage cables for computers or telephones need to be concealed.

We offer a variety of accessories such as end caps, junctions and corners in a silver finish PVC-u to co-ordinate with this range of profiles.

MAS97 profiles are fixed to the wall using screw fixings.

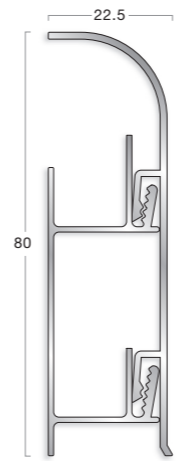
| CODE / PROFILE | FINISHES | LENGTH | END CAPS | JUNCTION | EXTERNAL CORNER | INTERNAL CORNER |
|--|---|---------|----------|----------|-----------------|-----------------|
| MAS97/8SF | Silver Anodised Aluminium with interlocking aluminium fixing brackets | 2.00m * | MAS97/8P | MAS97/8G | MAS97/8E | MAS97/8I |
|  | | | | | | |

* Note: 3 fixing brackets supplied per length.

All accessories are supplied in packs of 4 except for End Caps which are supplied as 4 sets of 2 (one left hand and one right hand)

Dimensions shown are nominal. Illustrations are 70% size in mm. Products subject to minor design alterations without notice.

Aluminium Cove Formers

Aluminium Cove Formers are perfect for use with LVT as they allow the flooring material to be covered up the wall to create a neat finish where the two meet. Our Aluminium Cove Formers are supplied in two profile designs featuring several anodised finishes, ideal for use within premium environments.

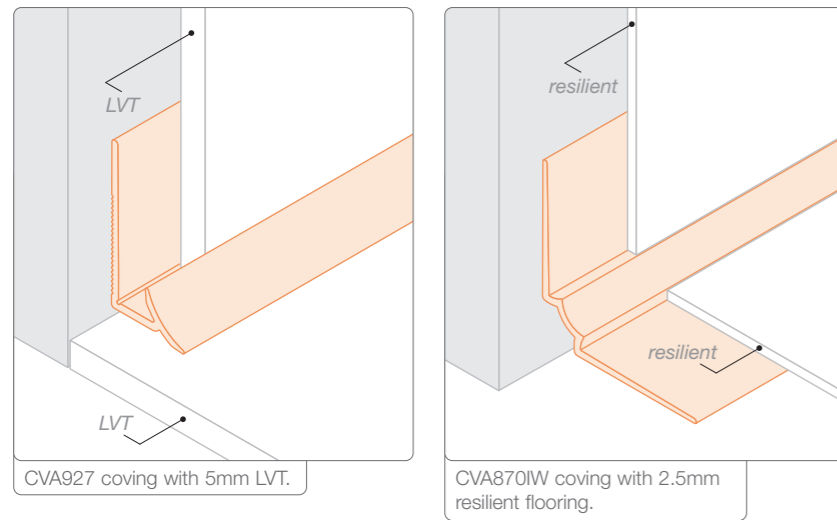

| CODE / PROFILE | MATERIAL | LENGTH | COLOURS / FINISHES |
|-----------------|-----------|--------|--|
| <p>CVA927</p> | Aluminium | 2.50m | F4 Silver Anodised |
| <p>CVA870IW</p> | Aluminium | 2.50m | <ul style="list-style-type: none"> F4 Silver Anodised F6 Bronze Anodised F9 Sand Anodised |

Dimensions shown are nominal. Illustrations are 70% size in mm. Products subject to minor design alterations without notice.

Visit us online at www.gradus.com where you can...

Find your nearest Gradus distributor:

Download a copy of the latest Gradus Distributor List from our website to find out where your nearest distributor is located.

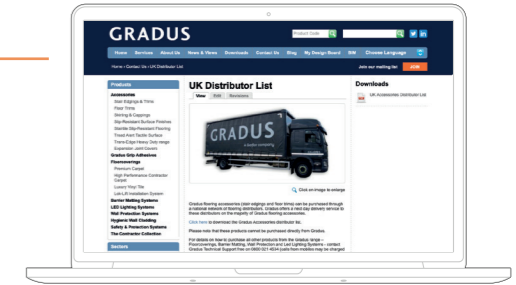

Order product samples:

Here you can select and save an unlimited number of Gradus products onto your own personal design board before ordering free samples for any products of interest.

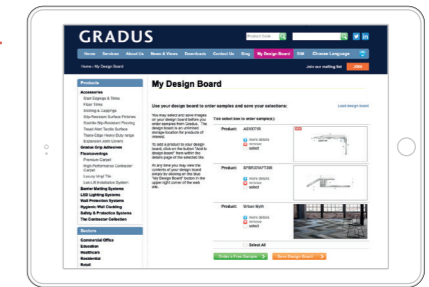

Discover our Gradus Grip flexible adhesive:

Gradus Grip is a rapid curing flexible adhesive suitable for bonding the majority of Gradus floor trims to most solid surfaces within internal environments.



ULTRA STRONG BOND FOR MOST SURFACES*

SAVE TIME & MONEY

GRADUS 10 YEAR WARRANTY*

NO MORE SCREWS AND PLUGS

*Further information can be found at www.gradus.com

View the full suite of Gradus product categories and download brochures:

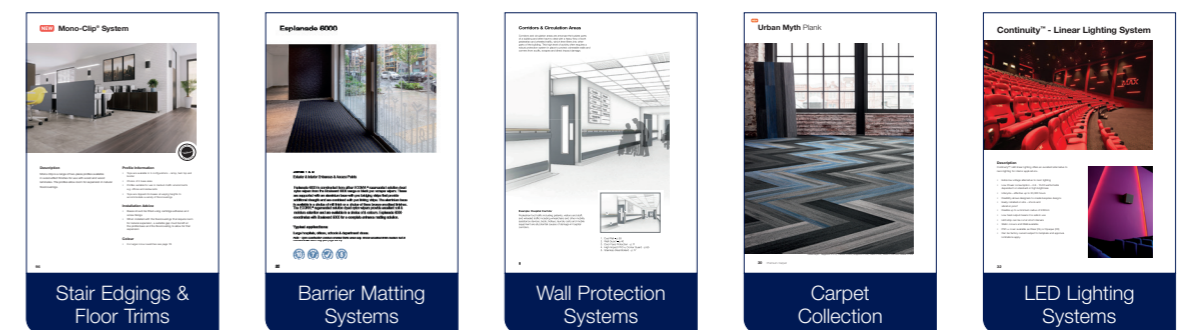

Don't forget to check us out on Social Media:

Follow us on twitter @Gradus_World

Keep up to date with us on LinkedIn – [graduslimited](https://www.linkedin.com/company/graduslimited)



GRADUS

Gradus Ltd Park Green Macclesfield Cheshire SK11 7LZ

For enquiries outside the UK and Eire contact Gradus International on +44 (0)1625 613780

Gradus International
England

Tel +44 (0) 1625 613780

Gradus Far East
Singapore

Tel: (+65) 6734 5933

call: 01625 428922

gradus.com